

Askari Compact (AC) Askari Compact (AC/SV)

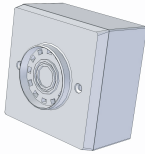

AC: 0832-CPD-0138
AC/SV: 0832-CPD-1653

EN54-3 Fire Alarm Device - Sounder
Dispositif d'alarme incendie EN54-3 - Avertisseur d'incendie
EN54-3 Feueralarmgerät - Töner
Dispositivo di allarme antincendio a norma EN54-3 - Sirena
EN54-3 Brandalarm - sounder
Dispositivo de alarma de incendios EN54-3 - Timbre de alarma
EN54-3 Brandvarnare - Signalgivare
EN54-3 Urządzenie systemów SAP - Sygnalizator

EN54-3		
18 ~ 28VDC 9 ~ 15VDC		9 ~ 28VDC
35mA (Max)		
0.28mm ² - 2.5mm ²		
Type A = -10°C ~ +55°C		
ABS V0		
Type A = IP21C		
6		32

*Product exceeds minimum requirements of EN54-3
See www.cooperfulleon.com
Le produit dépasse les exigences minimum de EN54-3
Voir www.cooperfulleon.com
Das Erzeugnis erfüllt die Mindestanforderungen von EN54-3.
Siehe www.cooperfulleon.com
Il prodotto supera i requisiti minimi previsti dalla norma EN54-3
Vedi www.cooperfulleon.com
Product overtreft de minimale vereisten van EN54-3.
Zie www.cooperfulleon.com
El producto excede los requisitos mínimos de la norma EN54-3
Véase www.cooperfulleon.com
Produkten överträffar minsta krav enligt EN54-3
Se www.cooperfulleon.com
Parametry techniczne produktu przekraczają minimalne
wymagania normy PN EN54-3, szczegółly www.cooperfulleon.com

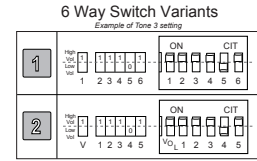
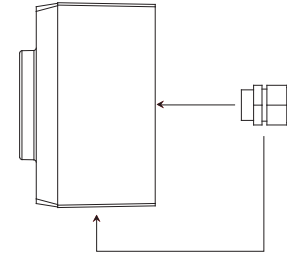
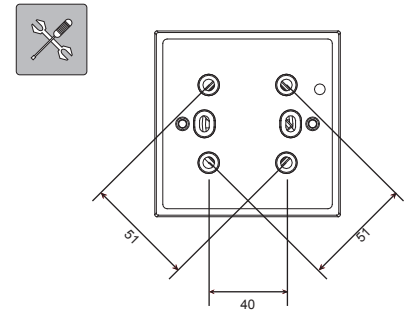
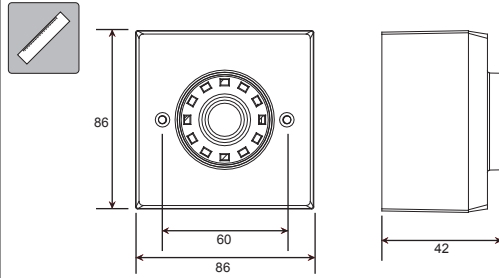

AC/SV

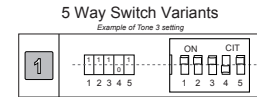

AC

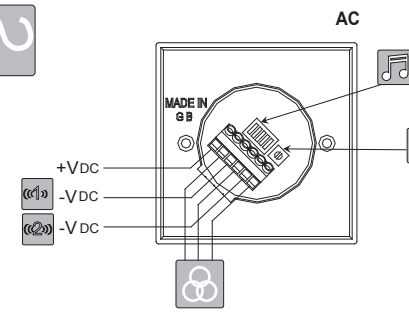

AC

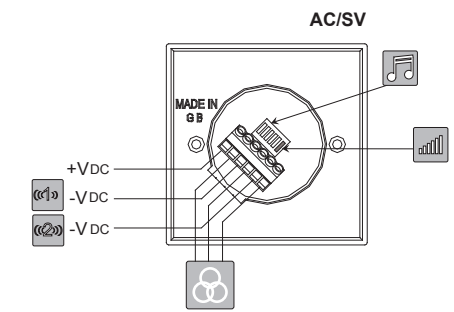

AC/SV

							@20°C		
							mA	dB(A)	EN54-3 Min SPL @ 28Vdc @ Max Volume @ Loudest node dB(A)
1	14	11111		800 & 970Hz	2Hz (250ms~250ms)	BS Fire Tone	18	95	-
2	14	11110		800 & 970Hz	7Hz (7/5)	BS Fire Tone	18	97	-
3	14	11101		800 & 970Hz	1Hz (1/s)	BS Fire Tone	18	97	94
4	14	11100		2850Hz	Steady	General Purpose	32	105	-
5	4	11011		2400 ~ 2850Hz	7Hz	General Purpose	30	106	-
6	4	11010		2400 ~ 2850Hz	1Hz	General Purpose	30	106	-
7	14	11001		500 ~ 1200Hz	3s Sweep, 0.5s silence, then repeat	Dutch fire (NEN 2575)	20	96	94
8	14	11000		1200 ~ 500Hz	1Hz	German fire (DIN 33 404)	16	95	93
9	4	10111		2400 & 2850Hz	2Hz (250ms~250ms)	General Purpose	30	105	-
10	14	10110		970Hz	0.5Hz (1s On / 1s Off)	PFEER alert	12	93	-
11	4	10101		800 & 970Hz	1Hz (500ms~500ms)	BS Fire Tone	18	95	-
12	4	10100		2850Hz	0.5Hz (1s On / 1s Off)	General Purpose	24	105	-
13	14	10011		970Hz	0.8Hz (250ms On / 1s Off)	General Purpose	8	90	-
14	14	10010		970Hz	Steady	PFEER toxic gas	20	94	95
15	14	10001		554 & 440Hz	100ms ~ 400ms	French fire (NFS 32-001)	12	91	-
16	16	10000		660Hz	3.3Hz (150ms On / 150ms Off)	Swedish (Air Raid)	9	88	-
17	17	01111		660Hz	0.28Hz (1.8s On / 1.8s Off)	Swedish (Local warning)	12	90	-
18	18	01110		660Hz	0.05Hz (13s Off / 6.5Hz On)	Swedish (Pre-mess)	14	91	-
19	19	01101		660Hz	Steady	Swedish (All Clear)	14	91	-
20	20	01100		554 & 440Hz	0.5Hz (1s On / 1s Off)	Swedish (Turn Out)	13	91	-
21	21	01011		660Hz	1Hz (500ms ~ 500ms)	Swedish General Purpose	10	89	-
22	14	01010		2850Hz	4Hz (150ms On / 100ms Off)	Pelican Crossing	22	105	-
23	14	01001		800 ~ 970Hz	50Hz	BS Fire Tone	18	96	-
24	4	01000		2400 ~ 2850Hz	50Hz	General Purpose	25	106	-
25	25	00111		970Hz	3 x 500ms pulses followed by 1.5s silence then repeat	ISO 8201	14	92	-
26	26	00110		800 ~ 970Hz	3 x 500ms pulsed sweep followed by 1.5s silence then repeat	ISO 8201	20	104	-
27	27	00101		970 & 800Hz	3 x 500ms pulsed two tone followed by 1.5s silence then repeat	ISO 8201	35	101	-
28	10	00100		800 & 970Hz	2Hz (250ms ~ 250ms)	BS Fire Tone	17	95	-
29	988Hz	00011		990 & 650Hz	2Hz (250ms ~ 250ms) (Symphoni Tones)	BS Fire Tone	17	97	94
30	510Hz	00010		510 & 610Hz	2Hz (250ms ~ 250ms) (Squashni Micro Tones)	BS Fire Tone	12	98	94
31	31	00001		300 ~ 1200Hz	1Hz	General Purpose	13	96	-
32	510Hz	00000		510 & 610Hz	1Hz Alternating (500ms ~ 500ms)	BS Fire	12	99	-

(i) Tones certified under the CPD (Fire Alarm Applications) are shown in the column marked EN54-3
(ii) All other SPL measurements are taken 'on axis' & are not third party verified.
(iii) Detailed EN54-3 polar SPL measurements are available in M96-024
(iii) A SPL of at least 65dB(A) is achieved in at least one direction at minimum volume/voltage.
(i) Les tons certifiés dans le cadre de la DPC (application alarme incendie) sont indiqués dans la colonne intitulée EN54-3.
(ii) Toutes les autres mesures NPA sont relevées « sur axe » et ne sont pas vérifiées par un tiers.
(iii) Les mesures NPA polaires détaillées EN54-3 sont disponibles dans M96-024
(i) Die nach CPD (Feuermelderanwendung) zertifizierten Töne sind in Spalte EN54-3.
(ii) Alle anderen Schalldruckmessungen wurden vom akustischen Mittelpunkt ab gelesen und von keiner unabhängigen Stelle verifiziert.
(iii) Detaillierte Polar-SPL-Messungen gemäß EN54-3 sind erhältlich in M96-024
(i) I toni della sirena certificati CPD (applicazione allarme antincendio) sono indicate nella colonna contrassegnata con EN54-3.
(ii) Tutte le altre misurazioni SPL sono state rilevate "sull'asse" e non sono state verificate da terzi.
(iii) Le misurazioni SPL polari ai sensi della norma EN54-3 sono disponibili in M96-024
(i) U vindt tonen die onder CPD (brandalarmtoepassing) zijn gecertificeerd, in de kolom waar EN54-3 staat vermeld.
(ii) Alle andere SPL-metingen zijn via de 'as' gedaan en niet door derden geverifieerd.
(iii) Uitgebreide polaire SPL-metingen voor EN54-3 zijn beschikbaar in M96-024

(i) Los sonidos certificados por el CPD (aplicación para alarmas de incendios) se muestran en la columna marcada con EN54-3.
(ii) Cualquier otra medida del SPL (nivel de intensidad acústica) se toma "sobre el eje" y no está verificada por terceras partes.
(iii) Las medidas detalladas del SPL polar EN54-3 están disponibles en M96-024
(i) Signaler som är certifierade för CPD (brandvarnare) visas i kolumnen märkt EN54-3.
(ii) Alla övriga mätningar av ljudtrycket har genomförts "direkt intill" och är inte bekräftade av tredje part.
(iii) Detaljerade polära mätningar av ljudtrycket enligt EN54-3 finns under M96-024
(i) Sygnaly tonowe zgodne z certyfikatem CPD dla systemów sygnalizacji pożaru wskazane są w kolumnie EN54-3.
(ii) Wszystkie pomiary SPL są wykonane w osi sygnalizatora i nie były poddane weryfikacji przez inną stronę.
(iii) Szczegółowe pomiary kątowych SPL wg EN54-3 dostępne są w M96-024.
CE marking under the CPD was affixed on: (see batch code on product)
La marque CE dans le cadre de la DPC a été apposée le : (voir code de lot sur le produit)
CE-Kennzeichnung unter dem CPD angebracht am: (siehe Chargencode am Erzeugnis).
La marcatura CE ai sensi della direttiva CPD è stata apposta su: (vedi codice sul prodotto)
CE-märkning under CPD är tillagad på: (se batchcode on het product)
CE-märkning enligt CPD fästes på: (se satskod på produkten)
Oznakowanie CE i CPD zostało naniesione na produkt.
Fulleon Ltd, Cwmbran, South Wales, U.K.
www.cooperfulleon.com